



US 20060149775A1

(19) **United States**  
 (12) **Patent Application Publication** (10) **Pub. No.: US 2006/0149775 A1**  
**Egnor** (43) **Pub. Date: Jul. 6, 2006**

(54) **DOCUMENT SEGMENTATION BASED ON VISUAL GAPS**

**Publication Classification**

(76) Inventor: **Daniel Egnor**, New York, NY (US)

(51) **Int. Cl.**  
*G06F 17/30* (2006.01)  
 (52) **U.S. Cl.** ..... 707/102

Correspondence Address:  
**HARRITY & SNYDER, L.L.P.**  
**Suite 300**  
**11240 Waples Mill Road**  
**Fairfax, VA 22030 (US)**

(57) **ABSTRACT**

A document may be segmented based on a visual model of the document. The visual model is determined according to an amount of visual white space or gaps that are in the document. In one implementation, the visual model is used to identify a hierarchical structure of the document, which may then be used to segment the document.

(21) Appl. No.: **11/024,851**

(22) Filed: **Dec. 30, 2004**

## My Favorite Restaurants

### Cafe Borrone

1010 El Camino Real, Menlo Park, California.

Cafe Borrone is my favorite breakfast place. Parking is easy in the underground garage. I meet friends and colleagues for breakfast here at least once a month! My favorite is their #2 breakfast -- eggs scrambled with Black Forest Ham and Cheddar.

### Carpaccio

1120 Crane Street, Menlo Park, California.

Our old standby dinner place in Menlo Park. This is the place for Italian food in Menlo Park. You can spend more (Del Baffo) but you can't get better price performance than at Carpaccio.

### Left Bank

635 Santa Cruz Avenue, Menlo Park, California.

A wonderful French bistro restaurant on Santa Cruz Avenue in downtown Menlo Park. Great private room upstairs in back. Had fabulous wild salmon on bed of the sweetest creamed corn in memory! Pork with spaetzle is always great. Braised veal cheeks make a wonderful stew. Wonderful desserts. Great wine.

## My Favorite Restaurants

Cafe Borrone  
1010 El Camino Real, Menlo Park, California.  
Cafe Borrone is my favorite breakfast place. Parking is easy in the underground garage. I meet friends and colleagues for breakfast here at least once a month! My favorite is their #2 breakfast -- eggs scrambled with Black Forest Ham and Cheddar.

Carpaccio  
1120 Crane Street, Menlo Park, California.  
Our old standby dinner place in Menlo Park. This is the place for Italian food in Menlo Park. You can spend more (Del Baffo) but you can't get better price performance than at Carpaccio.

Left Bank  
635 Santa Cruz Avenue, Menlo Park, California.  
A wonderful French bistro restaurant on Santa Cruz Avenue in downtown Menlo Park. Great private room upstairs in back. Had fabulous wild salmon on bed of the sweetest creamed corn in memory! Pork with spaetzle is always great. Braised veal cheeks make a wonderful stew. Wonderful desserts. Great wine.

**FIG. 1**

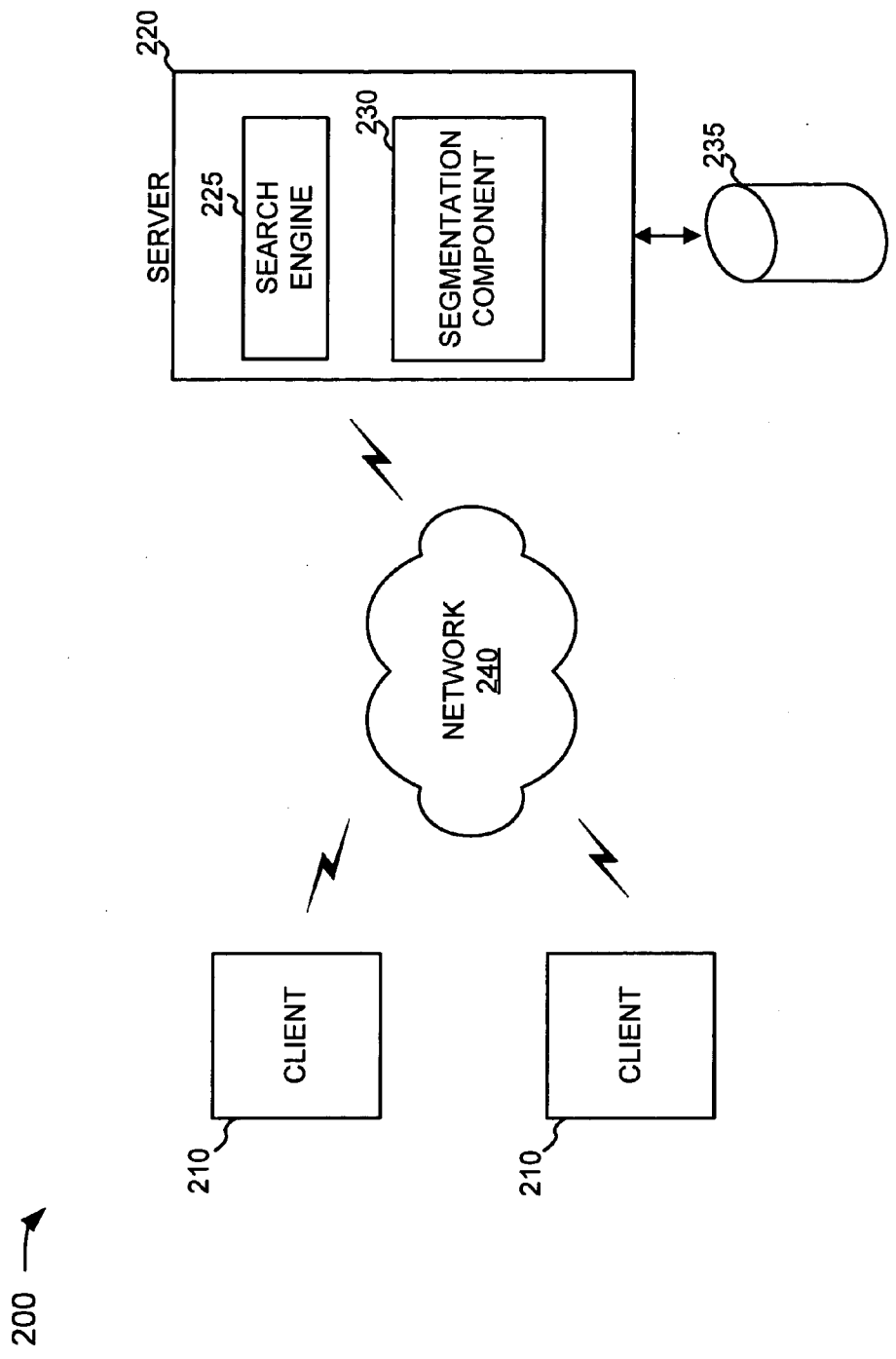

FIG. 2

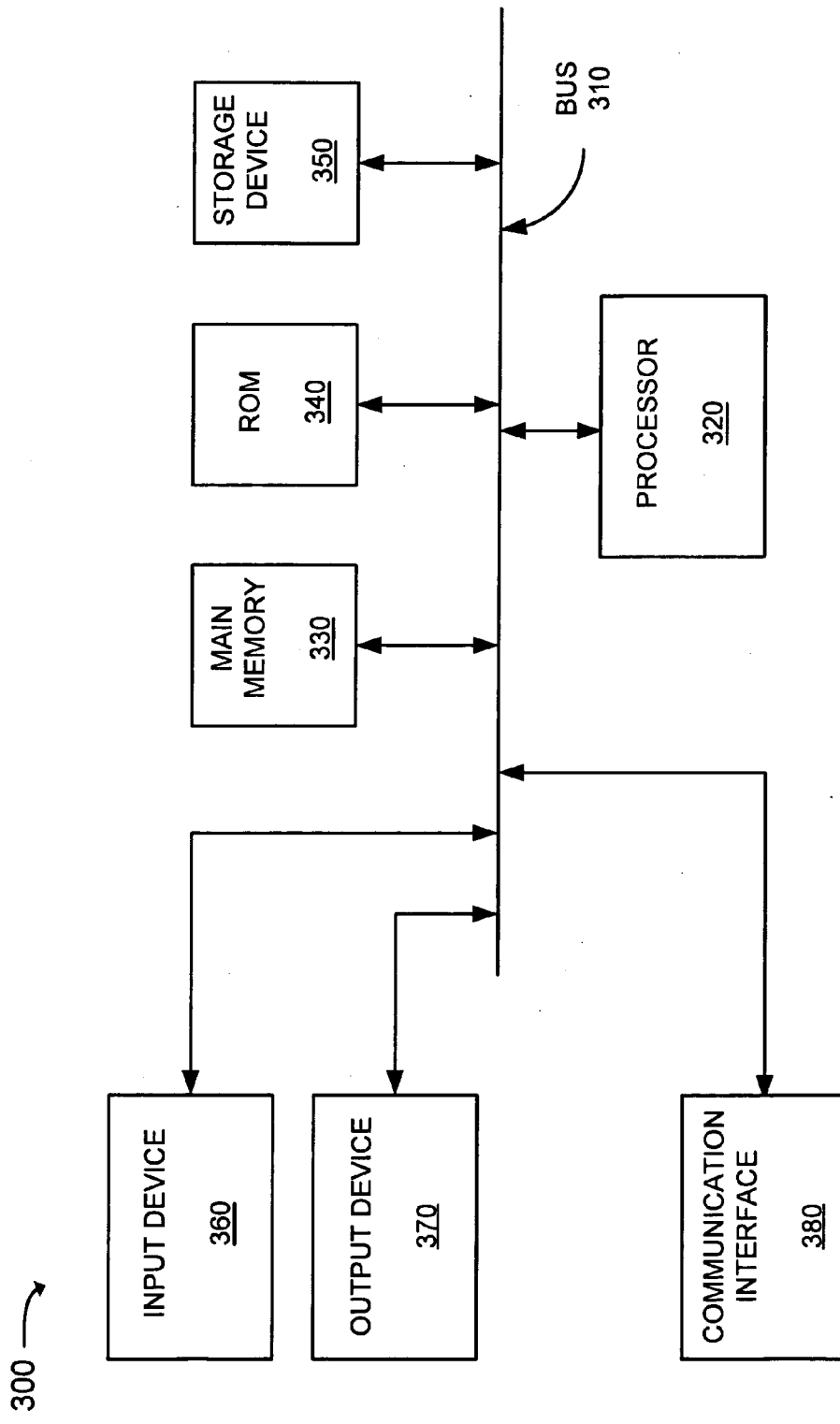

FIG. 3

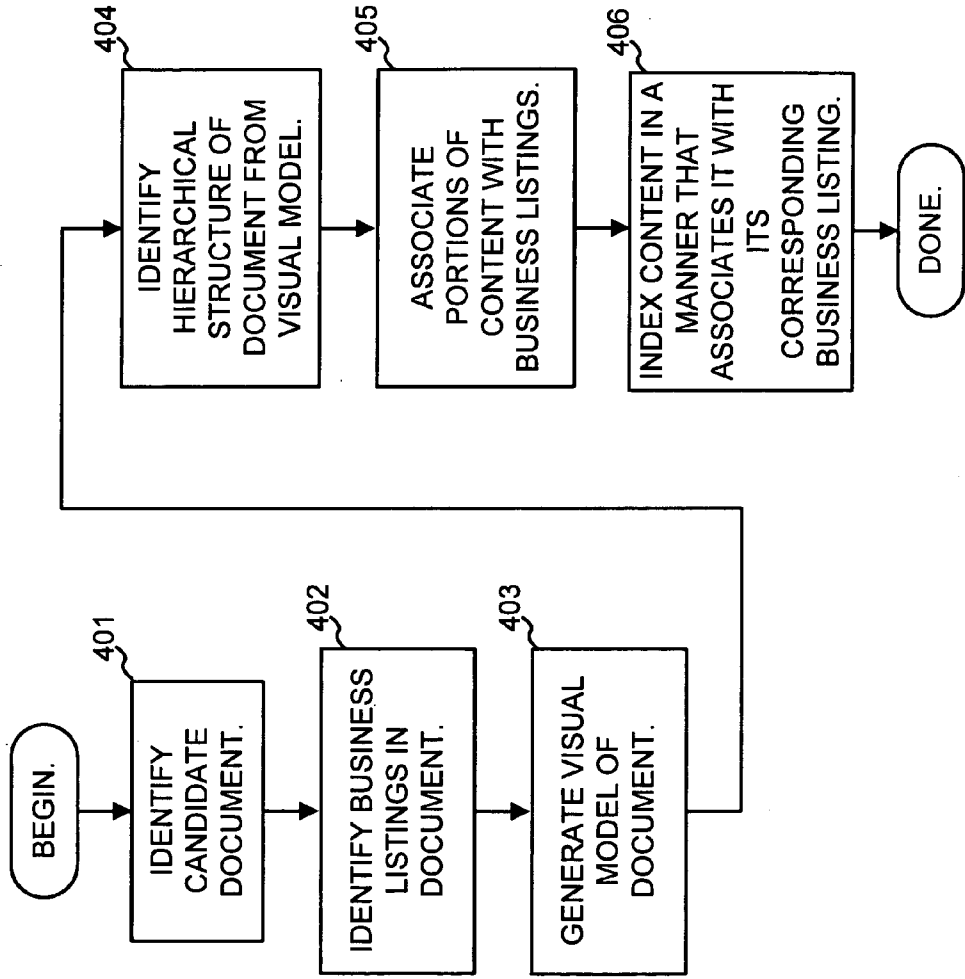

FIG. 4

# TOP RESTAURANTS IN FAIRFAX, VA <sup>510</sup>

500

## 520-1 ~ CHINESE

The **Hunan Eatery** on University Drive specializes in good eats. They make excellent fried rice and soups! Hunan Eatery, 4008 University Dr, Fairfax, VA. ~ 530-1

Looking for great noodles, check out **Noodles & Co.** This place is great and their food is reasonably priced. 10296 Main Street, Fairfax, VA. ~ 530-2

## 520-2 ~ ITALIAN

**Cafe Italia** is by far my favorite Italian joint. All of their desserts are excellent, particularly the tiramisu. 10515 Main Street, Fairfax, VA. ~ 530-3

If I had to pick one place that everyone will like, it's the **Florentine Restaurant**. A large selection of pasta and chicken dishes. Located at 4004 University Dr, Fairfax, VA. ~ 530-4

### FIG. 5

600 ↘

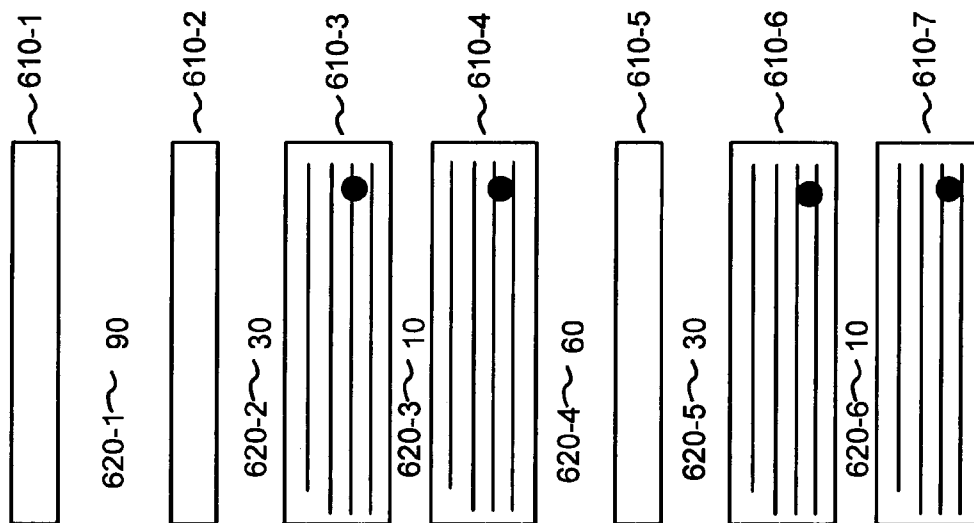
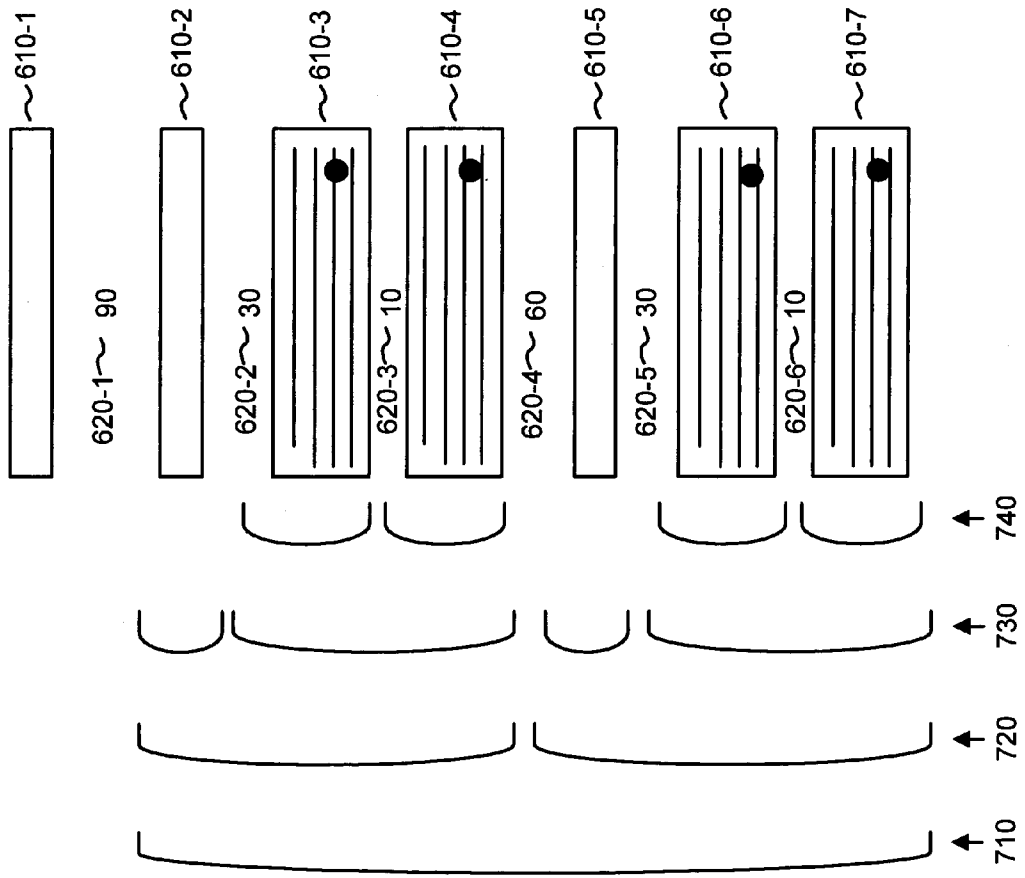

Fig. 6

Fig. 7





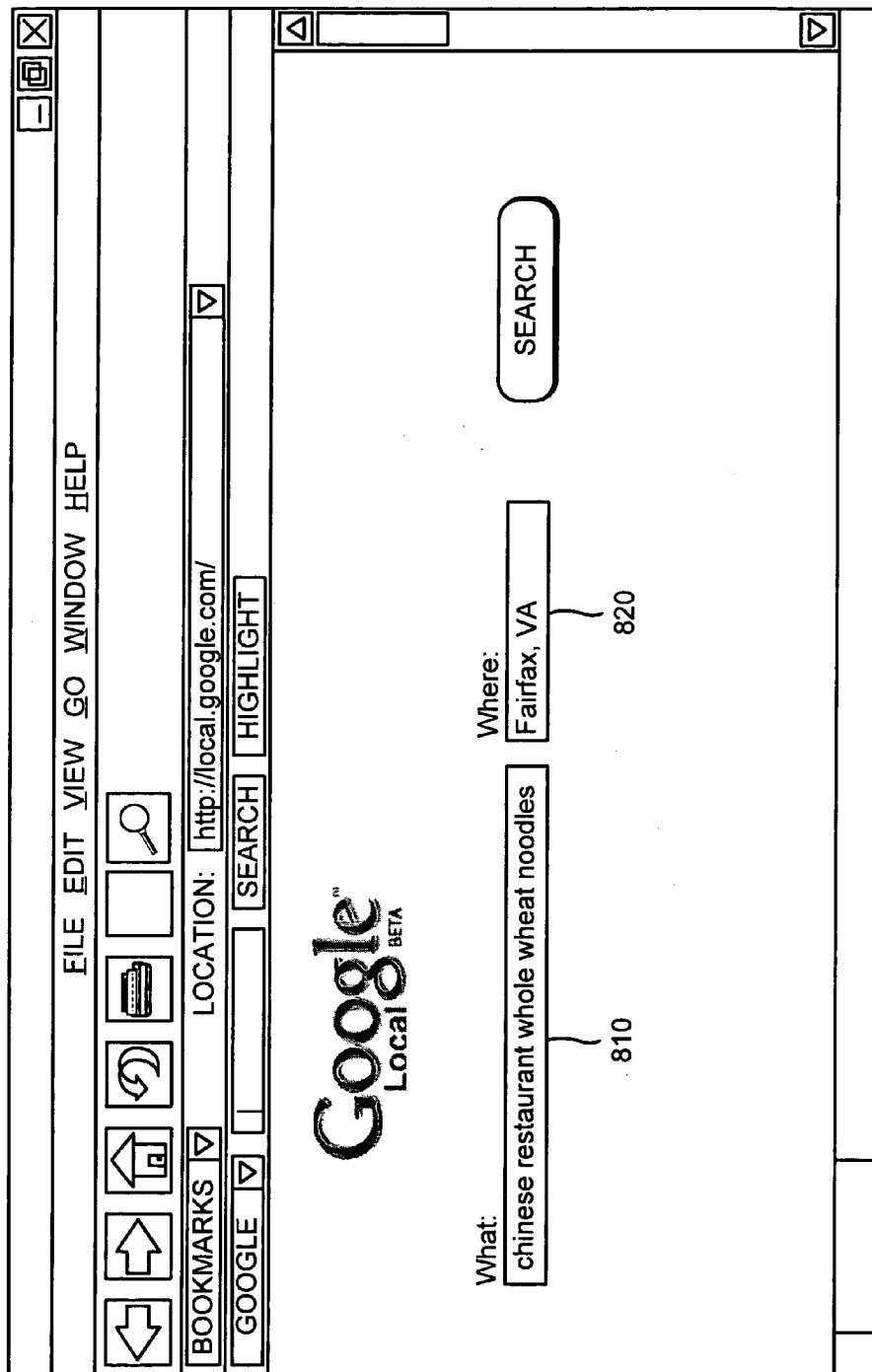

FIG. 8

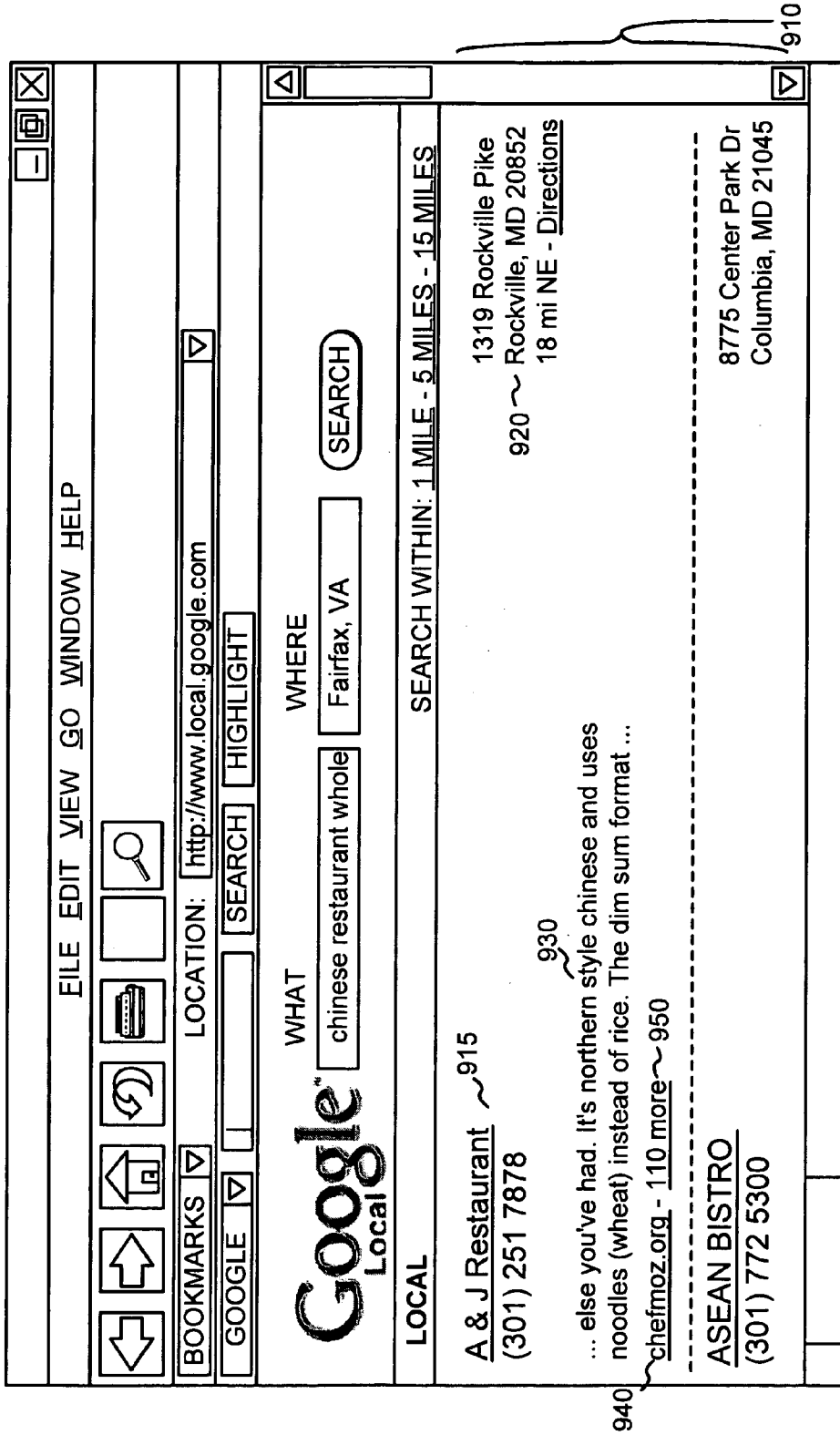

FIG. 9

**DOCUMENT SEGMENTATION BASED ON VISUAL GAPS**

**BACKGROUND**

[0001] A. Field of the Invention

[0002] Concepts described herein relate to search engines and, more particularly, to segmenting documents for indexing by a search engine.

[0003] B. Description of Related Art

[0004] The World Wide Web (“web”) contains a vast amount of information. Locating a desired portion of the information, however, can be challenging. This problem is compounded because the amount of information on the web and the number of new users inexperienced at web searching are growing rapidly.

[0005] Search engines attempt to return hyperlinks to web pages in which a user is interested. Generally, search engines base their determination of the user’s interest on search terms (called a search query) entered by the user. The goal of the search engine is to provide links to high quality, relevant results (e.g., web pages) to the user based on the search query. Typically, the search engine accomplishes this by matching the terms in the search query to a corpus of pre-stored web pages. Web pages that contain the user’s search terms are “hits” and are returned to the user as links.

[0006] In an attempt to increase the relevancy and quality of the web pages returned to the user, a search engine may attempt to sort the list of hits so that the most relevant and/or highest quality pages are at the top of the list of hits returned to the user. For example, the search engine may assign a rank or score to each hit, where the score is designed to correspond to the relevance and/or importance of the web page.

[0007] Local search engines may attempt to return relevant web pages within a specific geographic region. One type of document that is particularly useful for local search engines are business listings, such as a business listing found in a yellow pages directory. When indexing a business listing, it may be desirable to associate other information with the business listing, such as discussions or reviews of the business that are found in other web pages. For example, a web page may include a list of restaurants in a particular neighborhood and a short synopsis or review of each restaurant. It is desirable for the local search engine to accurately associate the text corresponding to each restaurant with the restaurant. Doing so can, for example, increase the search engine’s knowledge of the business and thus allow it to potentially provide more relevant results to the user.

**SUMMARY**

[0008] One aspect is directed to a method for segmenting a document. The method includes generating a visual model of the document, identifying a hierarchical structure of the document based on the visual model, and segmenting the document based on the hierarchical structure and on the visual model of the document.

[0009] Another aspect is directed to a method of indexing a document. The method includes identifying geographic signals in the document and segmenting the document into sections that correspond to different ones of the identified geographic signals based on a visual layout of the document.

The method further includes indexing text in the sections of the document as corresponding to business listings associated with the geographic signals.

[0010] Yet another aspect is directed to a device that includes a processor and a computer-readable memory. The memory includes programming instructions that when executed by the processor cause it to obtain a document that includes geographic signals, segment the document into sections that correspond to different ones of the identified geographic signals based on a visual layout of the document, and index text in the sections of the document as corresponding to business listings associated with the geographic signals.

**BRIEF DESCRIPTION OF THE DRAWINGS**

[0011] The accompanying drawings, which are incorporated in and constitute a part of this specification, illustrate an embodiment of the invention and, together with the description, explain the invention. In the drawings,

[0012] **FIG. 1** is a diagram of an exemplary document illustrating aspects consistent with the invention;

[0013] **FIG. 2** is an exemplary diagram of a network in which systems and methods consistent with the principles of the invention may be implemented;

[0014] **FIG. 3** is an exemplary diagram of a client or server of **FIG. 2** according to an implementation consistent with the principles of the invention;

[0015] **FIG. 4** is a flow chart illustrating exemplary operations consistent with aspects of the invention for segmenting documents having local relevance;

[0016] **FIG. 5** is a diagram illustrating a portion of an exemplary document;

[0017] **FIG. 6** is a diagram conceptually illustrating a visual model of a document;

[0018] **FIG. 7** is an exemplary diagram of a visual model illustrating a hierarchical structure for document; and

[0019] **FIGS. 8 and 9** are exemplary diagrams of user interfaces that may be presented to a user according to an implementation consistent with the principles of the invention.

**DETAILED DESCRIPTION**

[0020] The following detailed description of the invention refers to the accompanying drawings. The detailed description does not limit the invention.

**Overview**

[0021] A local search engine is described that returns local documents, such as web documents and business listings, in response to a local search query. When indexing and/or categorizing a document, the search engine may use information from other documents to help describe the document. For example, a third party restaurant review may be used to augment the search engine’s ability to retrieve relevant restaurants or return the relevant restaurants in response to a search query relating to restaurants.

[0022] Some documents, such as some web documents, may contain descriptive information for a number of differ-

ent business listings. **FIG. 1** is a diagram of an exemplary document containing descriptive information for three different restaurants, "Café Borrone," "Carpaccio," and "Left Bank." The descriptions of the restaurants are each in the paragraph following the restaurant name. From the point of view of the reader, the document's visual structure, such as its use of white space, clearly distinguishes which description corresponds to which restaurant. Conventional automated techniques for analyzing a document, such as that in **FIG. 1**, can have difficulty distinguishing the appropriate text that corresponds to each restaurant. These conventional techniques may rely on the underlying document structure, such as, for a hyper-text markup language (HTML) document, the document object model (DOM), to attempt to determine a hierarchical structure of the document. The underlying document structure, however, does not always correspond to the displayed visual structure of the document. Accordingly, such techniques can be inadequate.

[0023] Consistent with aspects of the invention, a segmentation component may automatically segment documents based on the visual layout of the document.

#### Exemplary Network Overview

[0024] **FIG. 2** is an exemplary diagram of a network **200** in which systems and methods consistent with the principles of the invention may be implemented. Network **200** may include clients **210** connected to a server **220** via a network **240**. Network **240** may include a local area network (LAN), a wide area network (WAN), a telephone network, such as the Public Switched Telephone Network (PSTN), an intranet, the Internet, or a combination of networks. Two clients **210** and one server **220** have been illustrated as connected to network **240** for simplicity. In practice, there may be more clients and/or servers. Clients **210** and server **220** may connect to network **240** via wired, wireless, or optical connections.

[0025] A client **210** may include a device, such as a wireless telephone, a personal computer, a personal digital assistant (PDA), a lap top, or another type of computation or communication device, a thread or process running on one of these devices, and/or an object executable by one of these devices. Server **220** may include a server device that processes, searches, and/or maintains documents. Clients **210** and server **220** may connect to network **240** via wired, wireless, or optical connections.

[0026] Server **220** may include a search engine **225** usable by clients **210**. Search engine **225** may be a local search engine designed to return documents having local relevance to the users. Server **220** may include segmentation component **230**. Segmentation component **230** may assist search engine **225** in indexing or classifying documents by automatically segmenting documents having local relevance into sections that correspond to different local regions or addresses.

[0027] The local documents processed by search engine **225** may be indexed and stored in a data structure, such as database **235**. The documents in database **235** may be local in the sense that they are associated with a particular geographic area—though not necessarily the same geographic area. A document that relates to a business listing, for example, can be considered a local document because it is associated with the particular address of the business.

[0028] A document, as the term is used herein, is to be broadly interpreted to include any machine-readable and machine-storable work product. A document may be an e-mail, a business listing, a file, a combination of files, one or more files with embedded links to other files, a news group posting, etc. In the context of the Internet, a common document is a web page. Web pages often include content and may include embedded information (such as meta information, hyperlinks, etc.) and/or embedded instructions (such as Javascript, etc.).

#### Exemplary Client/Server Architecture

[0029] **FIG. 3** is an exemplary diagram of a client **210** or server **220**, referred to as computing device **300**, according to an implementation consistent with the principles of the invention. Computing device **300** may include a bus **310**, a processor **320**, a main memory **330**, a read only memory (ROM) **340**, a storage device **350**, an input device **360**, an output device **370**, and a communication interface **380**. Bus **310** may include a path that permits communication among the components of computing device **300**.

[0030] Processor **320** may include any type of conventional processor, microprocessor, or processing logic that may interpret and execute instructions. Main memory **330** may include a random access memory (RAM) or another type of dynamic storage device that stores information and instructions for execution by processor **320**. ROM **340** may include a conventional ROM device or another type of static storage device that stores static information and instructions for use by processor **320**. Storage device **350** may include a magnetic and/or optical recording medium and its corresponding drive.

[0031] Input device **360** may include a conventional mechanism that permits a user to input information to computing device **300**, such as a keyboard, a mouse, a pen, voice recognition and/or biometric mechanisms, etc. Output device **370** may include a conventional mechanism that outputs information to the user, including a display, a printer, a speaker, etc. Communication interface **380** may include any transceiver-like mechanism that enables computing device **300** to communicate with other devices and/or systems. For example, communication interface **380** may include mechanisms for communicating with another device or system via a network, such as network **240**.

[0032] Server **220**, consistent with the principles of the invention, performs certain searching or document retrieval related operations through search engine **225** and/or segmentation component **230**. Search engine **225** and/or segmentation component **230** may be stored in a computer-readable medium, such as memory **330**. A computer-readable medium may be defined as one or more physical or logical memory devices and/or carrier waves.

[0033] The software instructions defining search engine **225** and/or segmentation component **230** may be read into memory **330** from another computer-readable medium, such as data storage device **350**, or from another device via communication interface **380**. The software instructions contained in memory **330** cause processor **320** to perform processes that will be described later. Alternatively, hardwired circuitry may be used in place of or in combination with software instructions to implement processes consistent with the present invention. Thus, implementations consistent

with the principles of the invention are not limited to any specific combination of hardware circuitry and software.

#### Segmentation Component Processing

[0034] FIG. 4 is a flow chart illustrating exemplary operations consistent with aspects of the invention for segmenting documents having local relevance. In general, segmentation component 230 may segment a document based on the visual layout of a document.

[0035] Segmentation component 230 may identify a candidate document for segmentation (act 401). A candidate document may be one that is identified to have one or more geographic signals relating to business listings. The geographic signals may include information associated with a location, such as a full or partial address of the location, a full or partial telephone number, and/or a full or partial name of a business associated with the location. The locations of the geographic signals within a document may be stored in database 235 by, for example, storing a word or character count that indicates where in the document each of the geographic signals is located.

[0036] The business listings in the document may be identified (act 402) based on the geographic signals. For instance, a business listing may be identified when a geographic signal can be determined to define a complete address and a business name. In some implementations, yellow page data or other pre-generated lists of businesses can be used to verify the identified business names/addresses.

[0037] FIG. 5 is a diagram illustrating a portion of an exemplary document 500. Exemplary document 500 is a HTML web document reviewing a number of restaurants. As shown, document 500 may include a document header 510, category labels 520-1 and 520-2, and individual restaurant reviews 530-1 through 530-4. As can be seen, document 500 includes four business listings, one of which is associated with each of reviews 530-1 through 530-4. When indexing this document, it would be desirable to associate each of the reviews with its corresponding business listing and not with any of the other business listings in document 500. Additionally, header information, such as document header 510 and category labels 520 can include useful descriptive information that may beneficially be associated with the business listings.

[0038] In situations in which document 500 is a web page, document 500 may be generated using a markup language, such as HTML. The particular HTML elements and style used to layout different web pages varies greatly. Although HTML is based on a hierarchical document object model (DOM), the hierarchy of the DOM is not necessarily indicative of the visual layout or visual segmentation of the document.

[0039] Segmentation component 230 may generate a visual model of the candidate document (act 403). The visual model may be particularly based on visual gaps or separators, such as white space, in the document. In the context of HTML, for instance, different HTML elements may be assigned various weights (numerical values) that attempt to quantify the magnitude of the visual gap introduced into the rendered document. In one implementation, larger weights may indicate larger visual gaps. The weights

may be determined in a number of ways. The weights may, for instance, be determined by subjective analysis of a number of HTML documents for HTML elements that tend to visually separate the documents. Based on this subjective analysis weights may be initially assigned and then modified ("tweaked") until documents are acceptably segmented. Other techniques for generating appropriate weights may also be used, such as based on examination of the behavior or source code of Web browser software or using a labeled corpus of hand-segmented web pages to automatically set weights through a machine learning process.

[0040] As an example of assigned weights, consider the HTML element <hr> (horizontal rule). The <hr> element may introduce a weight of 20 before and after the element. As another example, the HTML elements <h1> through <h6> are used to start new headings in which <h1> is the most prominent and <h6> is the least prominent. The corresponding elements </h1> through </h6> are used to end the headings. The various headings may, for example, be assigned weights such as, for <h2>, a weight of 50 before and 30 after the element (i.e., <h2> may be assigned a weight of 50 and </h2> a weight of 30. This reflects the concept that heading text is more likely to be associated with what comes after it than what comes before it.

[0041] FIG. 6 is a diagram conceptually illustrating a visual model of document 500. Visual model 600 includes a number of textual elements 610-1 through 610-7, which correspond to the textual elements (document header 510, category label 520-1, reviews 530-1 and 530-2, category label 520-2, and reviews 530-3 and 530-4, respectively) shown in FIG. 5. Weights 620-1 through 620-6 are assigned between textual elements 620-1 through 620-6. The circles shown in textual elements 610-3, 610-4, 610-6, and 610-7 represent the corresponding business listing shown in FIG. 5.

[0042] For the exemplary visual model 600, assume that text 610-2 and 610-5 are implemented as <h2> HTML elements, which correspond to weight values of 30 for weights 620-2 and 620-5, and the weight value of 60 (50 from text 610-5 and 10 from text 610-4) for weight 620-4. Weight 620-1, having a value of 90, may be calculated as the sum of the weight associated with text 610-2 (50) and the weight associated with the document header in text 610-1. Document header text 610-1 may be implemented using, for example, a number of HTML <br> (break) elements or as an HTML header element that contribute(s), for example, a weight value of 40 to the total value of weight 620-1. Weights 620-3 and 620-6 may be based on, for example, <br> elements after each of the document reviews 530 (i.e., text 610-3, 610-4, 610-6, and 610-7).

[0043] Returning to FIG. 4, the hierarchical structure of the document may be determined based on the visual model (act 404). In one implementation, different weights may define different hierarchical levels, in which larger weights define higher levels. The lowest level may be determined as a minimum weight that divides the textual elements containing geographic signals.

[0044] FIG. 7 is a diagram of visual model 600 illustrating a hierarchical structure for document 500. Brackets are used to indicate hierarchical regions. In this example, weight 620-1 is the largest weight and is near the top of the document, and may thus indicate that text 610-1 is the

document title or header (hierarchical level 710). At the next hierarchical level (hierarchical level 720), weights 620-1 and 620-4 define two divisions of three text sections each. Within this hierarchical level (hierarchical level 730), weights 620-2 and 620-5 separate the sections. Finally, weights 620-3 and 620-6 separate text sections 610-3 and 610-4, and text sections 610-6 and 610-7 (hierarchical level 740). These text sections include the geographic signals.

[0045] Based on the hierarchical levels determined in act 404, portions of the document may be associated with the business listings in the document (act 405). In one implementation, the text associated with the smallest hierarchical level surrounding a business listing may be associated with that business listing. Additionally, text at higher levels that is not associated with a different business listing may be associated with the business listing. In the example of FIGS. 5 and 6, for instance, text 530-2/610-4 may be associated with the business listing for the restaurant "Noodles & Co.," as well as with the text "Chinese" and the title "Top Restaurants in Fairfax, Va."

[0046] The content determined for each of the business listings may be associated with the appropriate business listing in database 235 (act 406). The business listing and its associated content may be indexed as a single combined document. In alternate implementations, the business listing and its corresponding content may be indexed separately but associated with one another via a special field in the index. In the examples of FIGS. 5-7, for instance, the business listing for "Hunan Eatery, 4008 University Drive, Fairfax, Va.," may be associated with review text 530-1, category label 520-1, and header 510.

[0047] Although the segmentation process described with reference to FIGS. 4-7 was described as segmenting a document based on geographic signals that correspond to business listings, the general hierarchical segmentation technique could more generally be applied to any type of signal in a document. For example, instead of using geographic signals that correspond to business listings, images in a document may be used (image signals). The segmentation process may then be applied to help determine what text is relevant to what image. Alternatively, the segmentation process described with reference to acts 403 and 404 may be performed on a document without partitioning the document based on a signal. The identified hierarchical segments may then be used to guide classifiers that identify portions of documents which are more or less relevant to the document (e.g., navigational boilerplate is usually less relevant than the central content of a page).

#### Example Search

[0048] FIGS. 8 and 9 are exemplary diagrams of user interfaces that may be presented to a user according to an implementation consistent with the principles of the invention. Assume that the user has accessed an interface associated with a local search engine, such as search engine 225 (FIG. 2). As shown in FIG. 8, the user may enter one or more search terms of a search query via a search field 810. The user may additionally enter a geographical region of interest in search field 820. In this example, the user has entered the search query "Chinese restaurants whole wheat noodles" and has indicated that the search should be performed in the geographic region corresponding to "Fairfax, Va."

[0049] Search engine 225 may implement the search over the pre-indexed document corpus stored in database 235. The index may have been generated using the techniques discussed above, such that business listings for Chinese restaurants may have also been associated with additional information that helps to more fully categorize and/or describe the business listings. In this case, search engine 225 may be able to locate a Chinese Restaurant in Fairfax, Va. that serves whole wheat noodles.

[0050] As shown in FIG. 9, search engine 225, via a user interface, may present local search results 910. For each of search results 910 (or some subset of the search results), the user interface may provide address information for the business associated with or mentioning the search result, a telephone number for the business, a snippet from a document associated with the business, a link to more information associated with the business, a link to directions to the business, and/or a link to one or more documents that refer to the business. The user interface may also provide a map of the area covered by the search. As shown, the first search result 910 includes business name and telephone information 915, address information 920, a snippet 930 from a document that describes the business (where the document may or may not be associated with the business), a link 940 to the document associated with snippet 930, and a link 950 for additional documents that refer to the business.

#### CONCLUSION

[0051] Systems and methods consistent with the principles of the invention may segment a document based on a visual model of the document. The segmented document may be used to associate different portions of the document with different items, such as different geographic signals/business listings.

[0052] The foregoing description of preferred embodiments of the present invention provides illustration and description, but is not intended to be exhaustive or to limit the invention to the precise form disclosed. Modifications and variations are possible in light of the above teachings or may be acquired from practice of the invention.

[0053] For example, while a series of acts has been described with regard to FIG. 4, the order of the acts may be modified in other implementations consistent with the principles of the invention. Further, non-dependent acts may be performed in parallel.

[0054] Also, exemplary user interfaces have been described with respect to FIGS. 8 and 9. In other implementations consistent with the principles of the invention, the user interfaces may include more, fewer, or different pieces of information.

[0055] Further, certain portions of the invention have been described as an "engine" that performs one or more functions. An engine may include hardware, such as an application specific integrated circuit or a field programmable gate array, software, or a combination of hardware and software.

[0056] It will be apparent to one of ordinary skill in the art that aspects of the invention, as described above, may be implemented in many different forms of software, firmware, and hardware in the implementations illustrated in the figures. The actual software code or specialized control

hardware used to implement aspects consistent with the principles of the invention is not limiting of the invention. Thus, the operation and behavior of the aspects were described without reference to the specific software code—it being understood that one of ordinary skill in the art would be able to design software and control hardware to implement the aspects based on the description herein.

[0057] No element, act, or instruction used in the present application should be construed as critical or essential to the invention unless explicitly described as such. Also, as used herein, the article “a” is intended to include one or more items. Where only one item is intended, the term “one” or similar language is used. Further, the phrase “based on” is intended to mean “based, at least in part, on” unless explicitly stated otherwise.

What is claimed:

1. A method for segmenting a document comprising:
  - generating a visual model of the document;
  - identifying a hierarchical structure of the document based on the visual model; and
  - segmenting the document based on the hierarchical structure and the visual model of the document.
2. The method of claim 1, wherein generating the visual model of the document includes:
  - assigning values to elements of the document used to control the appearance of the document, the values quantifying an amount that the elements introduce visual gaps in a displayed version of the document.
3. The method of claim 2, wherein the elements of the document are hyper-text markup language (HTML) elements.
4. The method of claim 2, wherein identifying the hierarchical structure of the document includes:
  - identifying higher hierarchical levels for the document as corresponding to larger assigned values.
5. The method of claim 1, further comprising:
  - identifying geographic signals in the document.
6. The method of claim 5, further comprising:
  - assigning values to elements of the document used to control the display of the document, the values quantifying an amount that the elements introduce visual gaps in a displayed version of the document; and
  - identifying a lowest level hierarchical structure of the document based on a minimum value that surrounds the geographic signals.
7. The method of claim 5, wherein segmenting the document further includes:
  - associating sections of the document with the geographic signals based on the identified hierarchical structure.
8. The method of claim 7, wherein segmenting the document further includes:
  - associating sections of text surrounding the geographic signals with the geographic signals.
9. The method of claim 7, wherein segmenting the document further includes:

associating text that is at a higher hierarchical level than the geographic signals and that does not itself include a geographic signal with the geographic signals as header text.

10. A computer-readable medium containing programming instructions for execution by a processor, the computer-readable medium comprising:

- programming instructions for generating a visual model of a document that includes at least one geographical signal;

- programming instructions for identifying a hierarchical structure of the document based on the visual model; and

- programming instructions for associating the at least one geographical signal with portions of the document based on the identified hierarchical structure of the document.

11. A method of indexing a document comprising:

- identifying geographic signals in the document;

- segmenting the document into a plurality of sections that correspond to different ones of the identified geographic signals based on a visual layout of the document; and

- indexing text in the plurality of sections of the document as corresponding to business information associated with the geographic signals.

12. The method of claim 11, wherein one of the geographic signals includes a postal address of a business.

13. The method of claim 11, wherein segmenting the document includes:

- generating a visual model of the document; and

- segmenting the document based on the visual model.

14. The method of claim 13, wherein segmenting the document includes:

- identifying a hierarchical structure of the document based on the visual model.

15. The method of claim 13, wherein segmenting the document includes:

- assigning values to elements of the document used to control the appearance of the document, the values quantifying an amount of visual gaps that the elements introduce in a displayed version of the document.

16. The method of claim 15, wherein the elements of the document are hyper-text markup language (HTML) elements.

17. The method of claim 14, wherein identifying the hierarchical structure of the document includes:

- assigning values to elements of the document used to control the display of the document, the values quantifying an amount that the elements introduce visual gaps in a displayed version of the document; and

- identifying higher hierarchical levels of the document as corresponding to larger assigned values.

18. The method of claim 14, wherein segmenting the document further includes:

- associating sections of text surrounding the geographic signals with the geographic signals.

19. The method of claim 14, wherein segmenting the document further includes:

associating text that is at a higher hierarchical level than a geographic signal and that does not itself include the geographic signal with the geographic signal as header text.

20. A system comprising:

means for identifying geographic signals in a document;

means for segmenting the document into a plurality of sections that correspond to different ones of the identified geographic signals based on a visual layout of the document;

means for indexing text in the plurality of sections of the document as corresponding to business listings associated with the geographic signals; and

means for storing the indexed text.

21. The system of claim 20, further comprising:

means for performing a local search based on a search query and the indexed text.

22. The system of claim 21, wherein results of the local search include a business listing relevant to the search query, the business listing being displayed with a snippet from a document relevant to the business listing.

23. A device comprising:

a processor; and

a computer-readable memory coupled to the processor and containing instructions that when executed by the processor cause the processor to:

identifying a document that includes signals,

segment the document into a plurality of sections that correspond to different ones of the identified signals based on a visual layout of the document, and

index text in the plurality of sections of the document as corresponding to the signals.

24. The device of claim 23, wherein the signals include geographic signals and the text is indexed to correspond to business listings associated with the geographic signals.

25. A method comprising:

identifying a document for indexing into a search engine index;

identifying references to business listings in the document;

generating a model of the document based on a visual layout of a displayed version of the document;

hierarchically segmenting the document based on the model and the references to the business listings; and

associating content in the document with particular ones of the business listings based on the hierarchical segmentation of the document.

26. The method of claim 25, wherein the document is a hyper-text markup language (HTML) document, and wherein generating the model further comprises:

assigning values to HTML elements of the document based on a predetermined decision of how much white space the HTML elements contribute to the visual layout of the displayed version of the document.

\* \* \* \* \*